

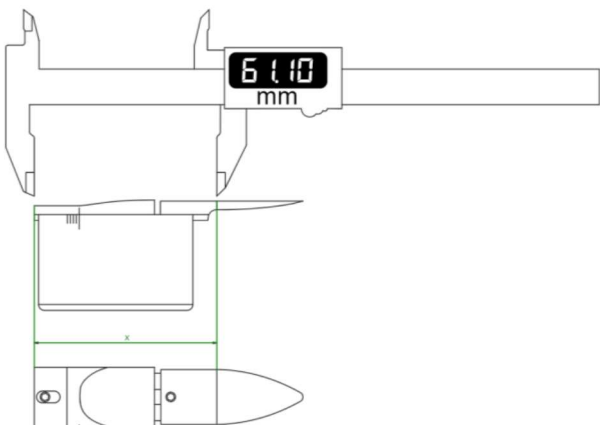

Einstellungshistorie

Anspitzhobelmaschine für Fagott und Kontrafagott

Position der Schablone	Abstand zu Gravur	Position des Knopfs	Schablone	Datum	Notizen
	61,2mm	0	FG1	12.1.19	Werkseinstellung
	62,2mm		FG1	2.2.19	Herz nach vorne, insgesamt dünner eingestellt













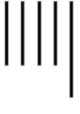

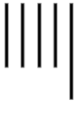

Der Abstand zur Gravur wird vom linken Ende der Schablone bis zur Gravurlinie auf der Zunge gemessen.

Besuchen Sie uns auf www.reedsnstuff.com/Support/Fagott für mehr Informationen und Ressourcen.

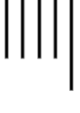
Einstellungshistorie

Anspitzhobelmaschine für Fagott und Kontrafagott

Position der Schablone	Abstand zu Gravur	Position des Knopfs	Schablone	Datum	Notizen
					
					
					
					
					
					
					

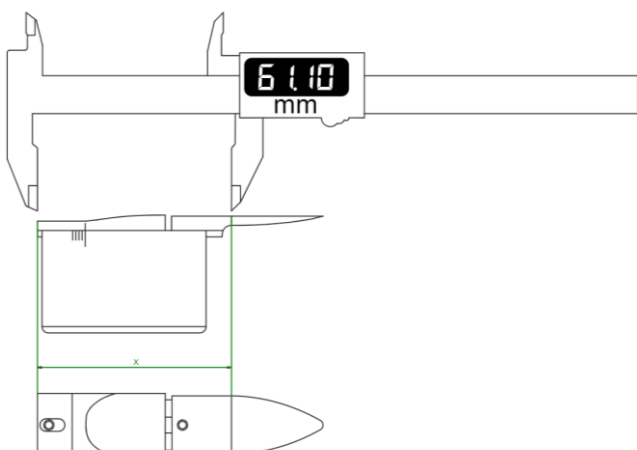











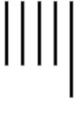

Der Abstand zur Gravur wird vom linken Ende der Schablone bis zur Gravurlinie auf der Zunge gemessen.

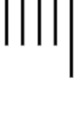
Besuchen Sie uns auf www.reedsnstuff.com/Support/Fagott für mehr Informationen und Ressourcen.

Einstellungshistorie

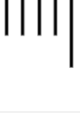
Anspitzhobelmaschine für Fagott und Kontrafagott

Position der Schablone	Abstand zu Gravur	Position des Knopfs	Schablone	Datum	Notizen
					
					
					
					
					
					
					
					
					
					
					
					
					

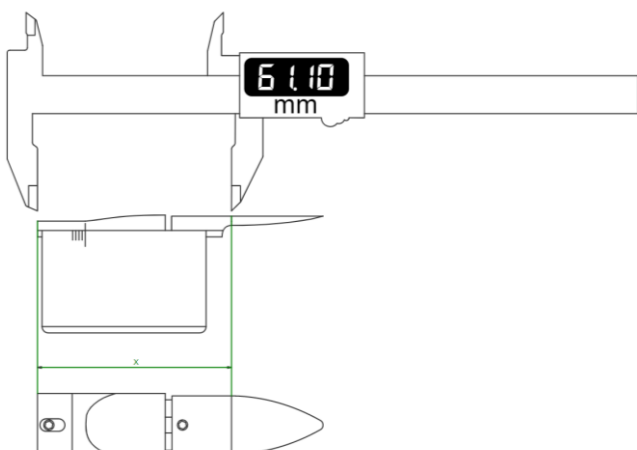

Der Abstand zur Gravur wird vom linken Ende der Schablone bis zur Gravurlinie auf der Zunge gemessen.

Besuchen Sie uns auf www.reedsnstuff.com/Support/Fagott für mehr Informationen und Ressourcen.